

SC 2 EasyFix



Deutsch	5
English	9
Français	14
Italiano	18
Nederlands	23
Español	28
Português	33
Dansk	38
Norsk	42
Svenska	46
Suomi	51
Ελληνικά	55
Türkçe	60
Русский	65
Magyar	70
Čeština	75
Slovenščina	79
Polski	84
Românește	88
Slovenčina	93
Hrvatski	98
Srpski	102
Български	107
Eesti	112
Latviešu	116
Lietuviškai	121
Українська	125
Қазақша	130
العربية	140



**Register
your product**

www.kärcher.com/welcome



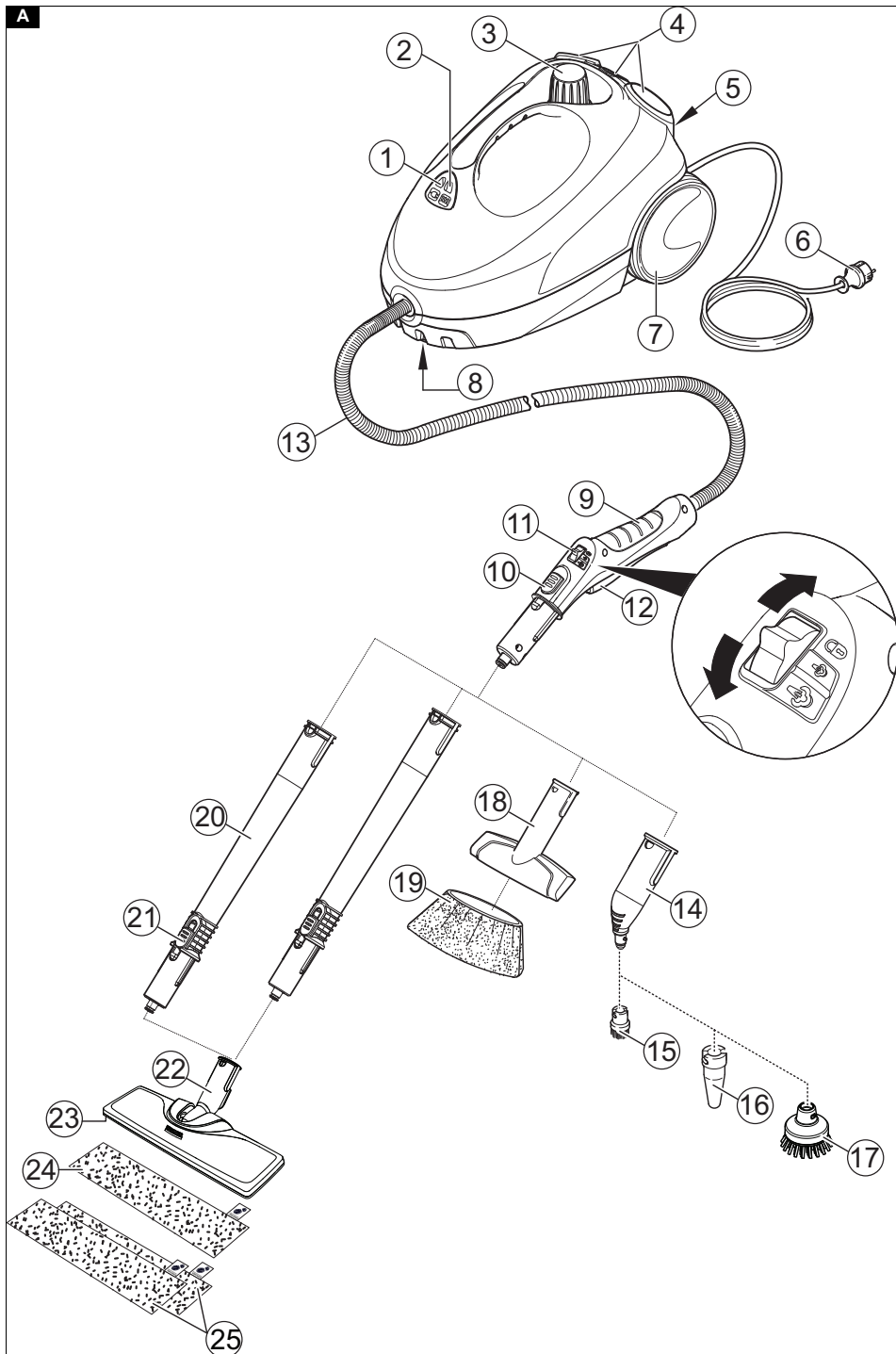

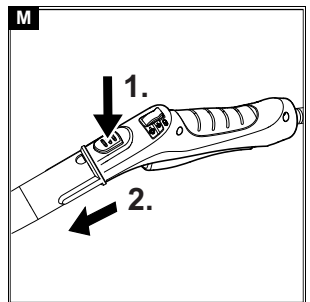
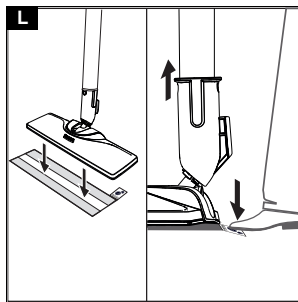
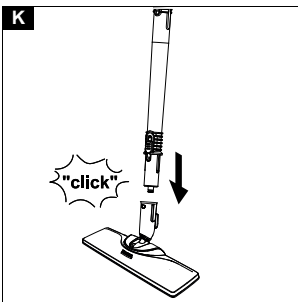
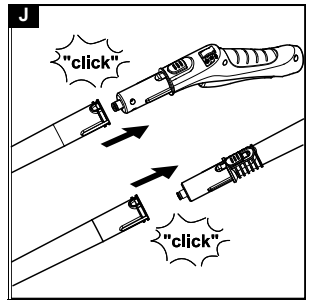
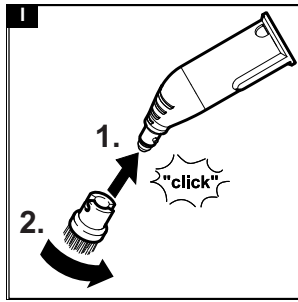
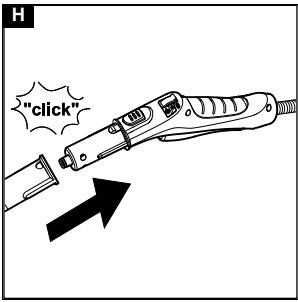
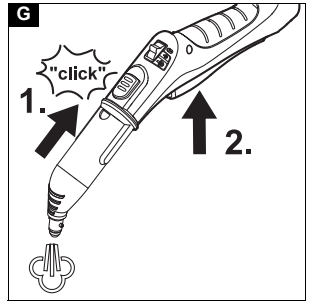
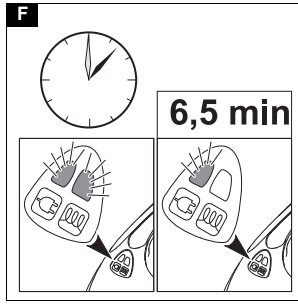
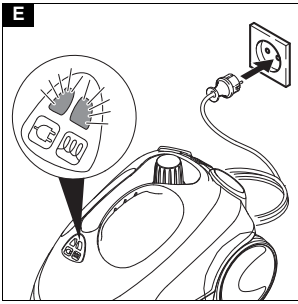
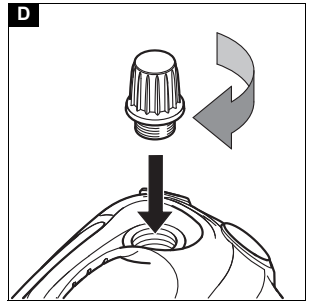
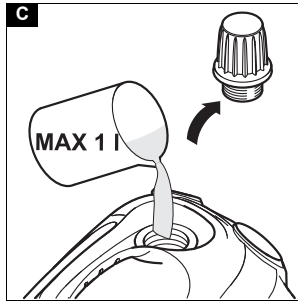
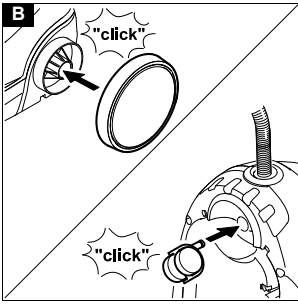

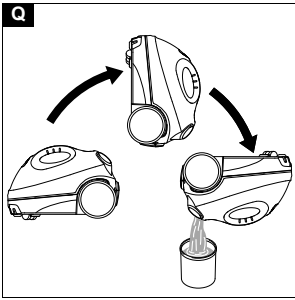
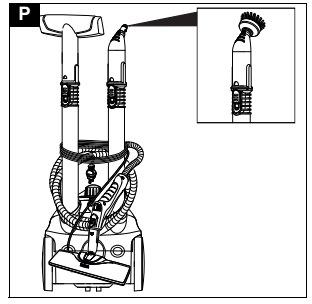
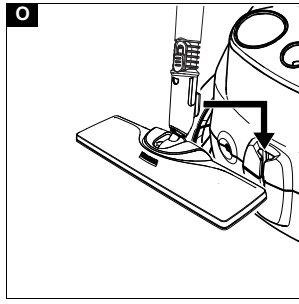
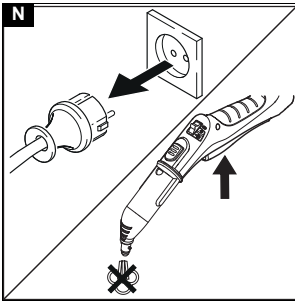

Contents

General notes.....	9
Intended use	9
Environmental protection	10
Accessories and spare parts.....	10
Scope of delivery.....	10
Warranty.....	10
Safety devices.....	10
Description of the device.....	10
Installation	11
Operation	11
Important application instructions.....	12
How to use the Accessories	12
Care and service	13
Troubleshooting guide.....	13
Technical data	13

General notes



Read these original operating instructions and the enclosed safety instructions before using the device for the first time. Proceed accordingly.

Keep both books for future reference or for future owners.

Intended use

Only use the appliance in private households. The appliance is intended for cleaning with steam and can be used with appropriate accessories as described in these operating instructions. Detergents are not required. Observe the safety instructions.

Environmental protection



The packing materials can be recycled. Please dispose of packaging in accordance with the environmental regulations.



Electrical and electronic appliances contain valuable, recyclable materials and often components such as batteries, rechargeable batteries or oil, which - if handled or disposed of incorrectly - can

pose a potential threat to human health and the environment. However, these components are required for the correct operation of the appliance. Appliances marked by this symbol are not allowed to be disposed of together with the household rubbish.

Notes on the content materials (REACH)

Current information on content materials can be found at: www.kaercher.com/REACH

Accessories and spare parts

Only use original accessories and original spare parts. They ensure that the appliance will run fault-free and safely.

Information on accessories and spare parts can be found at www.kaercher.com.

Scope of delivery

The scope of delivery for the appliance is shown on the packaging. Check the contents for completeness when unpacking. If any accessories are missing or in the event of any shipping damage, please notify your dealer.

Warranty

The warranty conditions issued by our relevant sales company apply in all countries. We shall remedy possible malfunctions on your appliance within the warranty period free of cost, provided that a material or manufacturing defect is the cause. In a warranty case, please contact your dealer (with the purchase receipt) or the next authorised customer service site. (See overleaf for the address)

Safety devices

⚠ CAUTION

Missing or modified safety devices

Safety devices are provided for your own protection. Never modify or bypass safety devices.

Symbols on the device

(according to type of appliance)

	Risk of burns, surface of appliance becomes hot during operation
	Risk of scalding from steam
	Read operating instructions

Pressure controller

The pressure controller keeps the pressure in the steam boiler as constant as possible during operation. The heating is switched off when the maximum operating pressure is reached in the steam boiler and is activated if there is a pressure drop in the steam boiler as a result of a steam removal.

Safety lock

The safety lock seals the steam boiler from the steam pressure present. If the pressure regulator is defective and overpressure occurs in the steam boiler, an pressure relief valve opens in the safety lock and steam leaks out through the lock.

Prior to restarting the appliance, contact the responsible KÄRCHER Customer Service.

Safety thermostat

The safety thermostat prevents the device from overheating. If the pressure controller fails and the device overheats, then the safety thermostat switches the device off.

To reset the safety thermostat, contact the responsible KÄRCHER Customer Service.

Description of the device

The maximum amount of equipment is described in these operating instructions. Depending on the model used, there are differences in the scope of delivery (see packaging).

For the illustrations, refer to the graphics page.

Illustration A

- ① Indicator light (green) - mains voltage present
- ② Indicator light (orange) - heating
- ③ Safety lock
- ④ Holder for accessories
- ⑤ Park bracket for floor nozzle
- ⑥ Mains connection with mains plug
- ⑦ Non-driven wheels
- ⑧ Steering roller
- ⑨ Steam gun
- ⑩ Unlocking button
- ⑪ Selector switch for steam volume (with child lock)
- ⑫ Steam lever
- ⑬ Steam hose
- ⑭ Spotlight nozzle
- ⑮ Round brush (small, black)
- ⑯ ** Power nozzle
- ⑰ ** Round brush (large)
- ⑱ Manual nozzle
- ⑲ Microfibre cover for manual nozzle
- ⑳ Extension tubes (2 x)
- ㉑ Unlocking button
- ㉒ Floor nozzle
- ㉓ Hook and loop fastener
- ㉔ Microfibre floor cloth (1 x)
- ㉕ ** Microfibre floor cloth (2 x)

** optional

Installation

Installing accessories

1. Insert and engage the steering roller and non-driven wheels.

Illustration B

2. Push the open end of the accessory onto the steam gun so that the unlocking button on the steam gun engages.

Illustration H

3. Push the open end of the accessory onto the spotlight nozzle.

Illustration I

4. Connect the extension tubes with the steam gun.
 - a Push the 1st extension tube onto the steam gun so that the unlocking button on the steam gun engages.

The connection pipe is connected.

- b Push the 2nd extension tube onto the 1st extension tube.

The connection pipes are connected.

Illustration J

5. Push the accessory and / or the floor nozzle onto the free end of the extension tube.

Illustration K

The accessory is connected.

Disconnecting accessories

1. Set the selector switch for the steam volume to the rear. The steam lever is locked.

2. Push the unlocking button and pull the parts apart.

Illustration M

Operation

Filling water

Note

Warm water reduces the heating-up time.

Note

Descaling the steam boiler is not required if commercially available distilled water is used.

1. Unscrew the safety lock.

Illustration C

2. Drain the water completely out of the steam boiler.

Illustration Q

3. Fill a maximum of 1 litre distilled water or tap water into the steam boiler.

Illustration C

4. Insert the safety lock.

Illustration D

Switch on the device

1. Place the device on a firm surface.

2. Insert the mains plug into a socket.

Illustration E

The green and orange indicator lights illuminate.

3. Wait until the orange indicator light - heating goes out.

Illustration F

4. Press the steam lever.

Illustration G



Steam leaks out.

Regulating the steam volume

Note

The device heating always switches on again during use to maintain the pressure in the steam boiler. The orange indicator light - heating illuminates to indicate this.

The expelled steam volume is regulated using the selector switch for steam volume. The selector switch has 3 positions:

	Maximum steam volume
	Reduced steam volume
	No steam - child lock Note <i>In this position, the steam lever cannot be operated.</i>

1. Set the selector switch for the steam volume to required steam volume.
2. Press the steam lever.
3. Before starting cleaning, point the steam gun at a cloth until steam is expelled evenly.

Topping up the water

If the steam volume is reduced during work or if no more steam volume comes out, the water will have to be refilled.

1. Switch the appliance off, see Chapter *Switch off the appliance*.
2. Unscrew the safety lock.
3. Fill a maximum of 1 l distilled water or tap water into the steam boiler.
4. Insert the safety lock.
5. Insert the mains plug into a socket.
6. Wait until the orange indicator light - heating goes out. The appliance is ready for use.

Switch off the appliance

1. Pull the mains plug out of the socket.
2. Press the steam lever until no more steam flows out.
Illustration N
The steam boiler is depressurised.
3. Set the child lock (selector switch for steam volume) to the rear.
The steam lever is locked.

Rinsing out the steam boiler

Rinse the appliance's steam boiler after max. every tenth boiler fill.

1. Switch the appliance off, see Chapter *Switch off the appliance*.
2. Allow the appliance to cool down.
3. Disconnect the accessory.
4. Fill the steam boiler with water and swing it around vigorously. Lime residue which has been deposited on the bottom of the steam boiler will be released as a result.
5. Drain the water completely out of the steam boiler.
Illustration Q

Storing the device

1. Connect the extension tubes to the large mounts for accessories.
2. Connect a manual nozzle and spotlight nozzle to each extension tube.
3. Fasten the large round brush to the spotlight nozzle.
4. Connect the small round brush and nozzles to the medium-sized mount for accessories.
5. Hang the floor nozzle in the park bracket.
Illustration O

6. Wind the steam hose around the extension tube and connect the steam gun to the floor nozzle.

Illustration P

7. Wind the mains cable around the extension tube.
8. Store the device in a dry location that is protected from frost.

ATTENTION

Material damage due to a stuck safety lock

If the safety lock is not removed after cleaning, there is a possibility that the lock could get stuck in the thread. After cleaning, unscrew the safety lock and store it, for example, with the other device accessories.

Important application instructions

Cleaning the floor areas

We recommend sweeping the floor or vacuum cleaning it before using the appliance. In this way the floor will be cleared of dirt and loose particles before the wet cleaning.

Freshening up textiles

Prior to using the appliance, always check the compatibility of the textiles at a concealed point: Steam down the textile, allow it to dry and then check it for any change in colour or shape.

Cleaning coated or painted surfaces

ATTENTION

Damaged surfaces

Steam can loosen wax, furniture polish, plastic coatings or paint and edge band from edges.

Do not direct the steam at glued laminated edges as the edge band may loosen.

Do not use the appliance for cleaning unsealed wood or parquet floors.

Do not use the appliance for cleaning painted or plastic coated surfaces such as kitchen or living room furniture, doors or parquet.

1. To clean these surfaces, steam a cloth briefly and use it to wipe over the surfaces.

Glass cleaner

ATTENTION

Glass breakages and damaged surfaces

Steam can damage sealed points of the window frame and, at low outside temperatures, lead to tension on the surface of window panes and hence to glass breakages.

Do not direct the steam at sealed points on the window frame. At low outside temperatures, heat up the window panes by gently steaming the full surface of the glass.

- Clean the window area with a manual nozzle and cover. To remove the water, use a squeegee or wipe the surfaces dry.

How to use the Accessories

Steam gun

The steam gun can be used for the following applications without accessories:

- For removing slight creases from the hanging clothing items: Steam the clothing item from a distance of 10-20 cm.
- For wiping damp dust: Steam a cloth briefly and use it to wipe over the furniture.

Spotlight nozzle

Round brush (small)

The small round brush is used for cleaning stubborn dirt. Stubborn dirt can be removed more easily by brushing.

ATTENTION

Damaged surfaces

The brush may scratch sensitive surfaces.

It is not suitable for cleaning sensitive surfaces.

1. Fit the round brush to the spotlight nozzle.

Illustration I

Round brush (large)

The large round brush is suitable for cleaning large rounded surfaces, e.g. wash basin, shower tray, bath tub, kitchen sink.

ATTENTION

Damaged surfaces

The brush may scratch sensitive surfaces.

It is not suitable for cleaning sensitive surfaces.

1. Fit the large round brush to the spotlight nozzle.

Illustration I

Power nozzle

The power nozzle is used for cleaning stubborn dirt, blowing down corners, joints etc.

1. Install the power nozzle onto the spotlight nozzle according to the round brush.

Illustration I

Manual nozzle

The manual nozzle is used for cleaning small areas that can be washed down, shower cubicles and mirrors.

1. Push the manual nozzle onto the steam gun according to the spotlight nozzle.

Illustration H

2. Pull the cover over the manual nozzle.

Floor nozzle

The floor nozzle is used for cleaning washable wall and floor coverings e.g. stone floors, tiles and PVC floors.

ATTENTION

Damage due to build-up of steam

Heat and moisture can lead to damage.

Check the heat resistance and steam effect on an inconspicuous area using a minimal volume of steam prior to use.

Note

Detergent residue or care emulsions on the surface to be cleaned can lead to streaks during steam cleaning, which will disappear however once these have been used several times.

We recommend sweeping the floor or vacuum cleaning it before using the device. In this way the floor will be cleared of dirt and loose particles before the wet cleaning commences. Work slowly on surfaces that are heavily soiled so that the steam has longer to take effect.

1. Connect the extension tubes with the steam gun.

Illustration J

2. Push the floor nozzle onto the extension tube.

Illustration K

3. Fasten the floor cleaning cloth to the floor nozzle.
 - a Place the floor cleaning cloth with the hook and loop fastener strips pointing upwards on the floor.
 - b Place the floor nozzle onto the floor cleaning cloth, applying slight pressure.

Illustration L

The floor cleaning cloth will stick to the floor nozzle of its own accord due to the hook and loop fastener.

Removing the floor cleaning cloth

1. Place one foot on the bottom corner of the floor cleaning cloth and lift the floor nozzle up.

Illustration L

Note

Initially, the floor cleaning cloth's hook and loop fastener strip is very strong and cannot be removed from the floor nozzle easily. After the floor cleaning cloth has been used several times and washed, it is easier to remove from the floor nozzle and it has reached the optimum adhesion.

Parking the floor nozzle

1. Hang the floor nozzle in the park bracket during breaks in work.

Illustration O

Care and service

Descaling the steam boiler

Note

Since the lime becomes caked on the appliance, we recommend descaling the appliance as specified in the table (BF=boiler fillings) based on the number of times the steam boiler is filled.

Hardness range	°dH	mmol/l	KF	
I	soft	0-7	0-1.3	55
II	Medium	7-14	1.3-2.5	45
III	Hard	14-21	2.5-3.8	35
IV	Very hard	>21	>3.8	25

Note

Your water board or municipal utilities authority can provide information on hardness of tap water.

ATTENTION

Damaged surfaces

The descaler may corrode sensitive surfaces.

Fill and empty the appliance carefully.

1. Switch off the device, see chapter *Switch off the appliance*.
2. Allow the device to cool down.
3. Unscrew the safety lock.
4. Drain the water completely out of the steam boiler.

Illustration Q

ATTENTION

Appliance damage due to descaler

An unsuitable descaler and incorrect dosing of the descaler may damage the appliance.

Only use KÄRCHER descaler.

Use 2 dosing units of the descaler for 1.0 l of water.

5. Apply descaler solution to the descaler according to the details.
6. Fill the descaler solution into the steam boiler. Do not seal the steam boiler.
7. Allow the descaler solution to take effect for approx. 8 hours.
8. Drain descaler solution completely out of the steam boiler.
9. Repeat the descaling process if necessary.
10. Rinse the steam boiler 2-3 times with cold water in order to drain all the descaler solution residue.
11. Drain the water completely out of the steam boiler.

Illustration Q

Care of accessories

(Accessories - depending on scope of delivery)

Note

The micro fibre cloths are not suitable for dryer.

Note

When washing the cloths, observe the instructions on the washing tag. Do not use any liquid softeners as this will affect the ability of the cloths to pick up dirt.

1. Wash the floor cleaning cloths and covers at a max. temperature of 60 °C in the washing machine.

Troubleshooting guide

Malfunctions often have simple causes that you can remedy yourself using the following overview. When in doubt, or in the case of malfunctions not mentioned here, please contact your authorised Customer Service.

⚠ WARNING

Risk of electric shock and burns

Trying to eliminate faults while the appliance is connected to the mains or has not yet cooled down is always dangerous.

Remove the mains plug.

Allow the appliance to cool down.

Reduced steam quantity

The steam boiler is scaled.

- Descale the steam boiler.

No steam

No water in the steam boiler

- Refill water, see Chapter *Topping up the water*.

The steam lever cannot be pressed

The steam lever is locked with the child lock.

- Set the child lock (selector switch for steam volume) to the front.

The steam lever is released.

Long heating-up time

The steam boiler is scaled.

- Descale the steam boiler.

High water egress

The steam boiler is too full.

- Press the steam gun until a little water comes out.

High water output

The steam boiler is scaled.

- Descale the steam boiler.

Technical data

Electrical connection

Voltage	V	220-240
Phase	~	1
Frequency	Hz	50-60
Protection class		IPX4
Protection category		I

Performance data

Heating capacity	W	1500
Maximum operating pressure	MPa	0.32
Heating-up time	Minutes	6.5
Continuous steaming	g/min	40
Maximum steam blast	g/min	100

Filling quantity

Steam boiler	l	1.0
--------------	---	-----

Dimensions and weights

Weight (without accessories)	kg	3.1
Length	mm	380
Width	mm	254
Height	mm	260

Subject to technical modifications.



THANK YOU!

MERCI! DANKE! ¡GRACIAS!



Registrieren Sie Ihr Produkt und profitieren Sie von vielen Vorteilen.

Register your product and benefit from many advantages.

Enregistrez votre produit et bénéficiez de nombreux avantages.

Registre su producto y aproveche de muchas ventajas.

www.kaercher.com/welcome



Bewerten Sie Ihr Produkt und sagen Sie uns Ihre Meinung.

Rate your product and tell us your opinion.

Évaluer votre produit et dites-nous votre opinion.

Reseñe su producto y díganos su opinión.



www.kaercher.com/dealersearch

Alfred Kärcher SE & Co. KG
Alfred-Kärcher-Str. 28-40
71364 Winnenden (Germany)

